

8 7 6 5 4 3 2 1

F

F

E

E

D

D

C

C

B

B

A

A

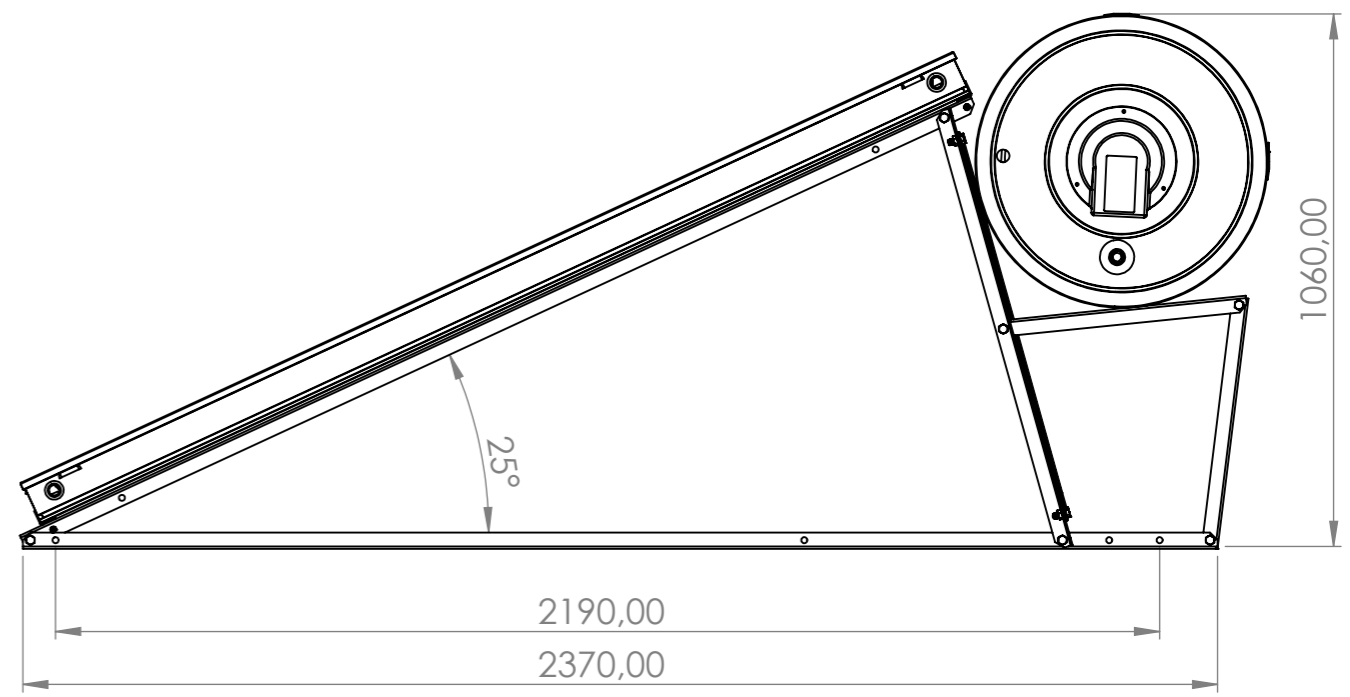
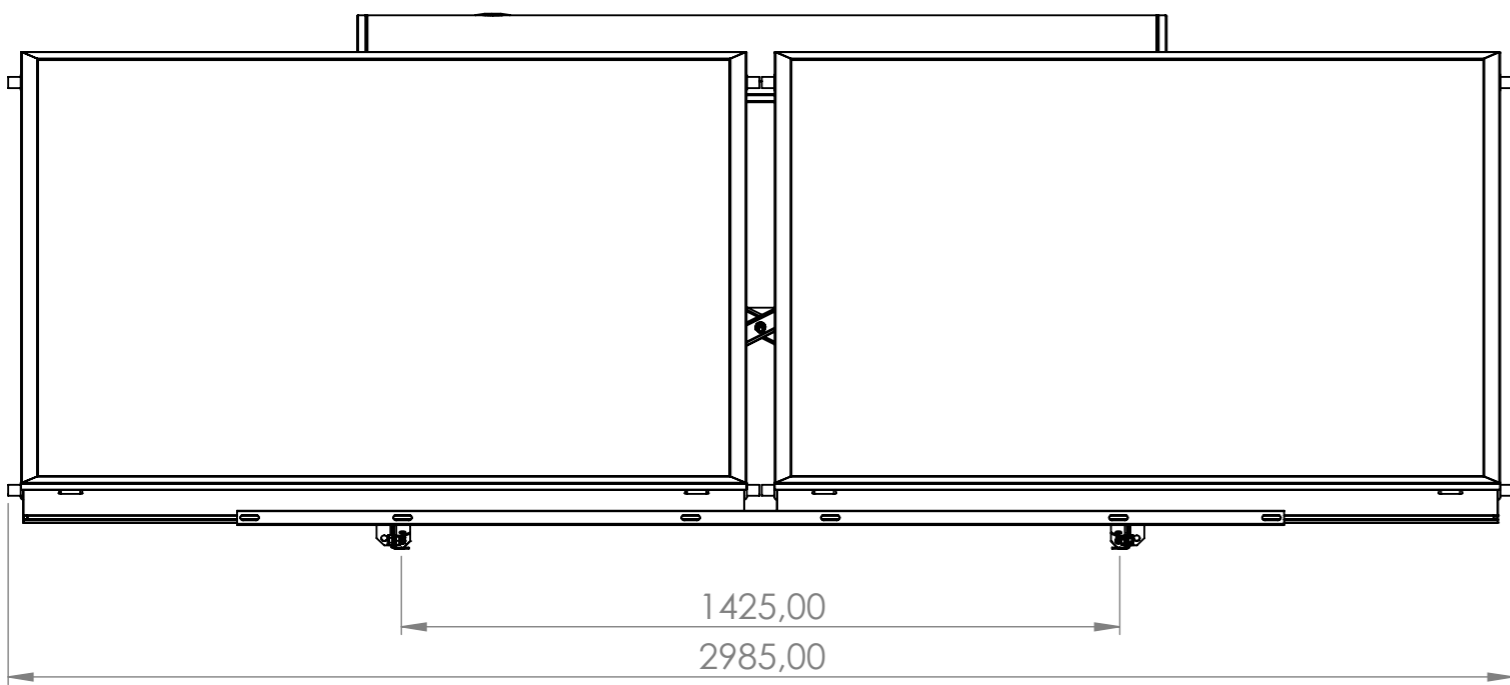

UNLESS OTHERWISE SPECIFIED: DIMENSIONS ARE IN MILLIMETERS SURFACE FINISH: TOLERANCES: LINEAR: ANGULAR:				FINISH:		DEBURR AND BREAK SHARP EDGES		DO NOT SCALE DRAWING		REVISION	
								 <b>Sammler</b> <sup>®</sup> SOLAR THERMAL SYSTEMS			
								TITLE:			
DRAWN		SPANOS TH		SIGNATURE		DATE					
CHK'D		MICHALOPOULOS									
APPV'D		MICHALOPOULOS									
MFG											
Q.A		GEORGIU				MATERIAL:		DWG NO.		A3	
								SSH338NV			
						WEIGHT:		SCALE:1:50		SHEET 1 OF 1	

8 7 6 5 4 3 2 1