

8 7 6 5 4 3 2 1

F

F

E

E

D

D

C

C

B

B

A

A

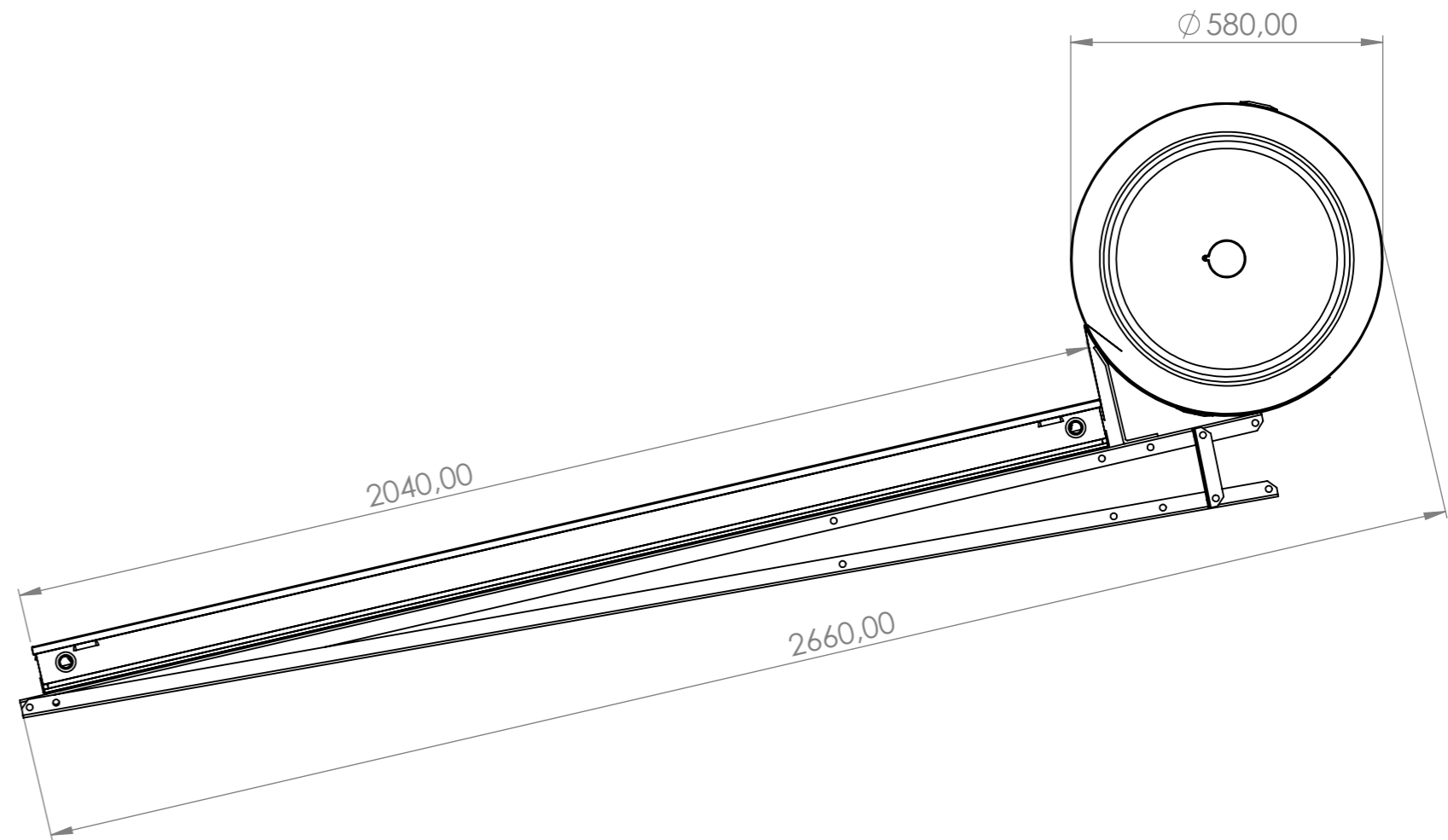
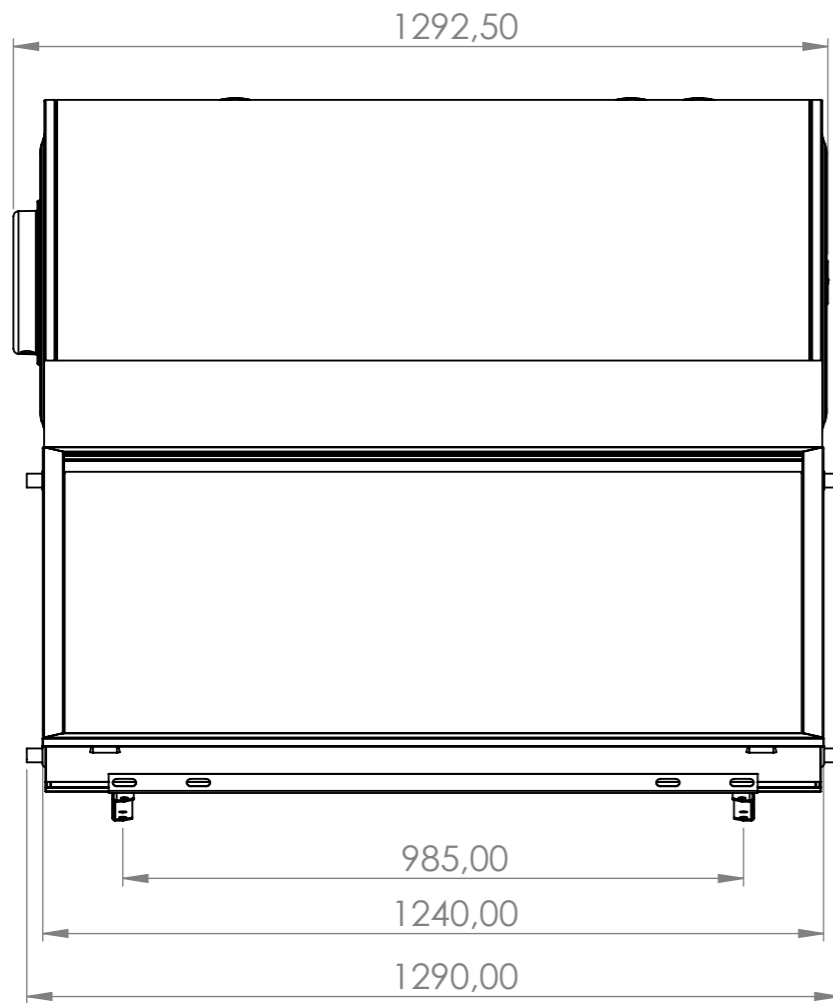

UNLESS OTHERWISE SPECIFIED: DIMENSIONS ARE IN MILLIMETERS SURFACE FINISH: TOLERANCES: LINEAR: ANGULAR:				FINISH:		DEBURR AND BREAK SHARP EDGES		DO NOT SCALE DRAWING		REVISION	
								 Sammler [®] SOLAR THERMAL SYSTEMS			
								TITLE:			
DRAWN		SPANOS TH		SIGNATURE		DATE					
CHK'D		MICHALOPOULOS									
APPV'D		MICHALOPOULOS									
MFG											
Q.A		GEORGIU						MATERIAL:		DWG NO.	
										A228-00NV	
										A3	
								WEIGHT:		SCALE:1:50	
										SHEET 1 OF 1	

8 7 6 5 4 3 2 1