

8 7 6 5 4 3 2 1

F

F

E

E

D

D

C

C

B

B

A

A

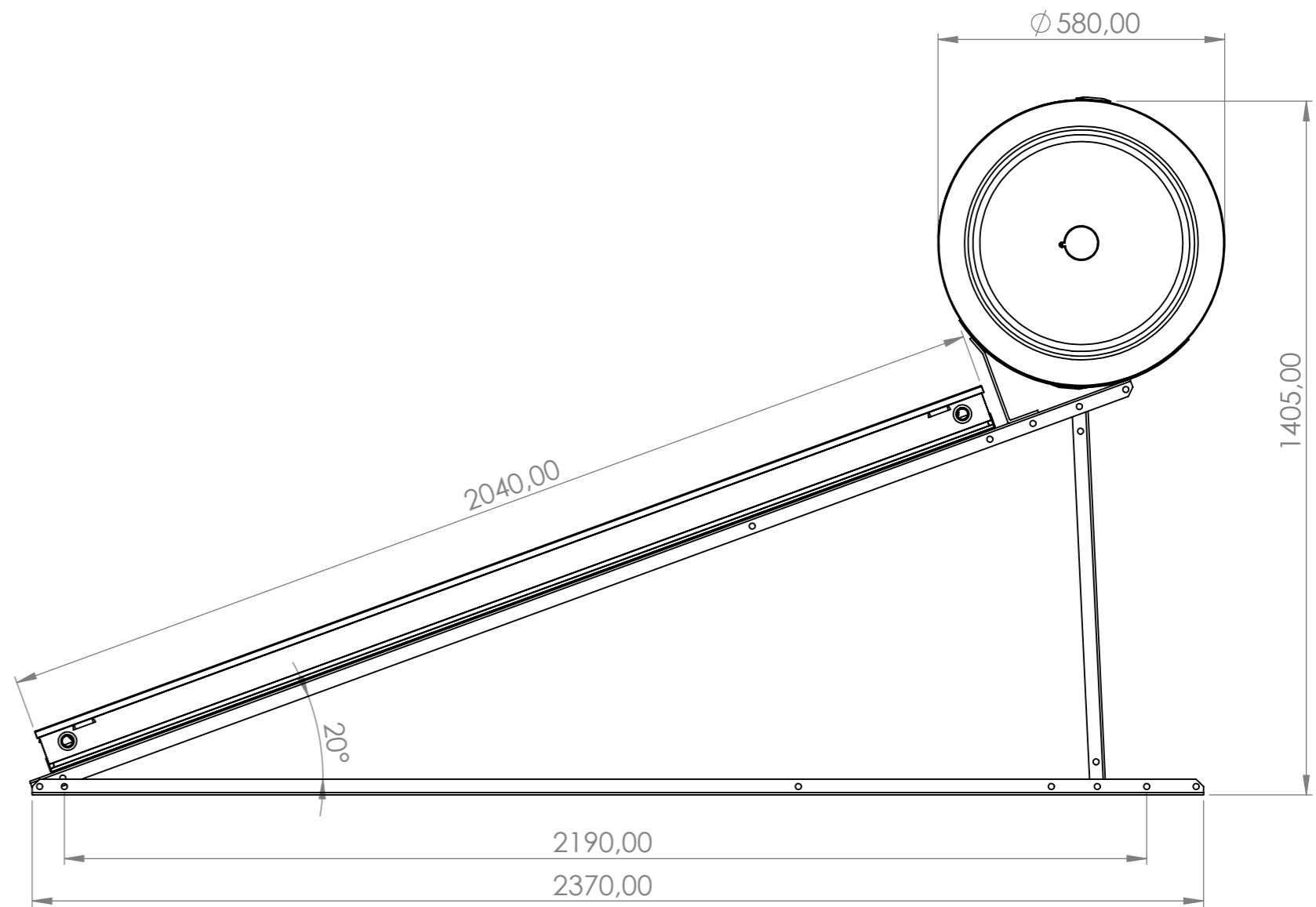
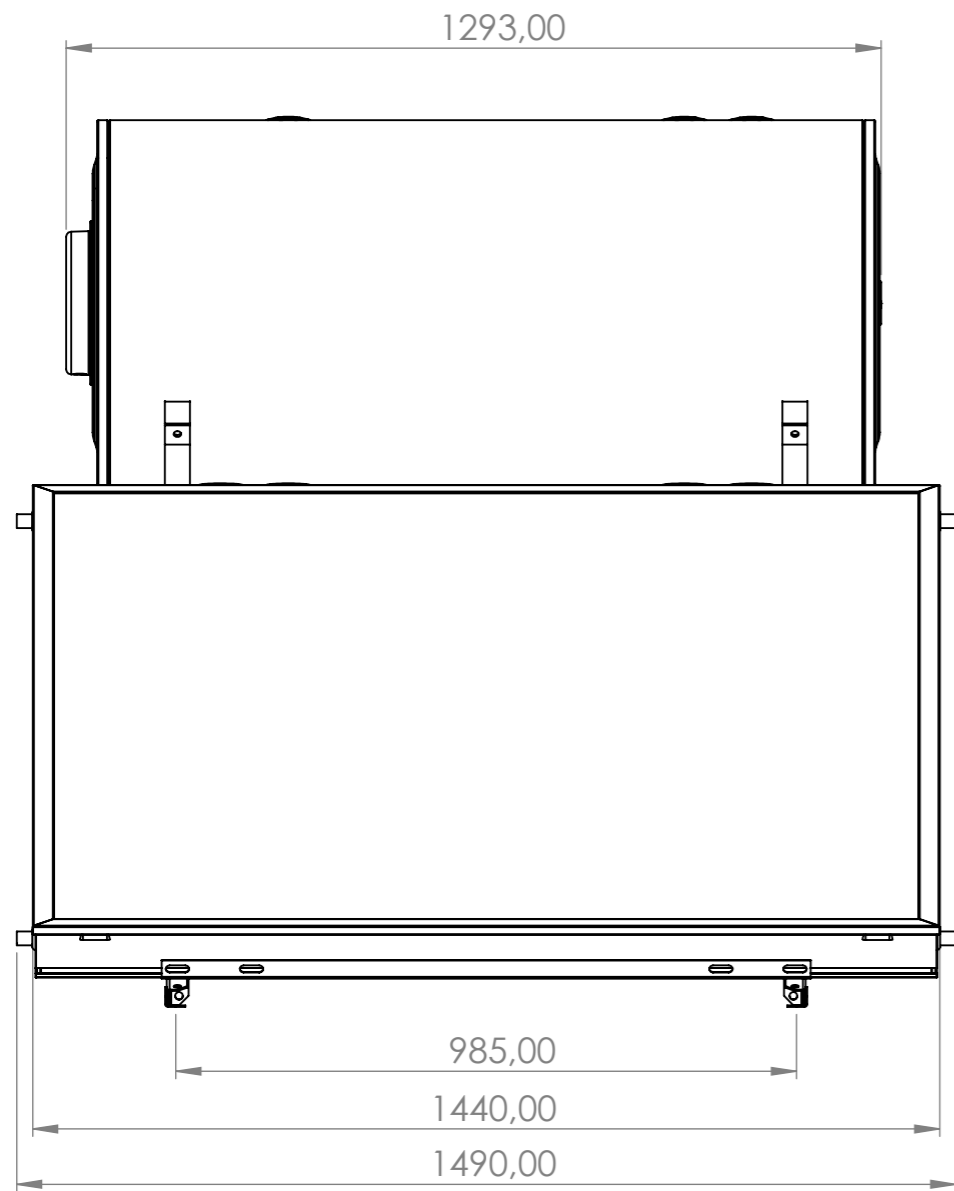

UNLESS OTHERWISE SPECIFIED: DIMENSIONS ARE IN MILLIMETERS SURFACE FINISH: TOLERANCES: LINEAR: ANGULAR:				FINISH:		DEBURR AND BREAK SHARP EDGES		DO NOT SCALE DRAWING		REVISION			
								 SOLAR THERMAL SYSTEMS					
								TITLE:					
								DWG NO.		S200-29-20NV		A3	
								WEIGHT:		SCALE:1:50		SHEET 1 OF 1	
DRAWN		SPANOS TH		SIGNATURE		DATE							
CHK'D		MICHALOPOULOS											
APPV'D		MICHALOPOULOS											
MFG													
Q.A		GEORGIU						MATERIAL:					

8 7 6 5 4 3 2 1